

# Technical Drawing

Part / Pièce #  
**8013**

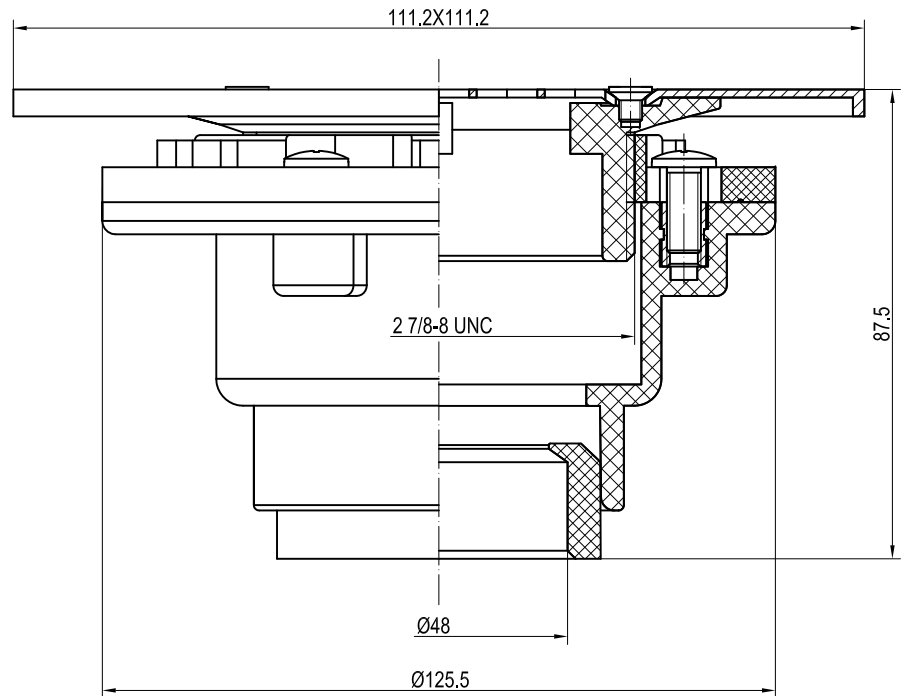
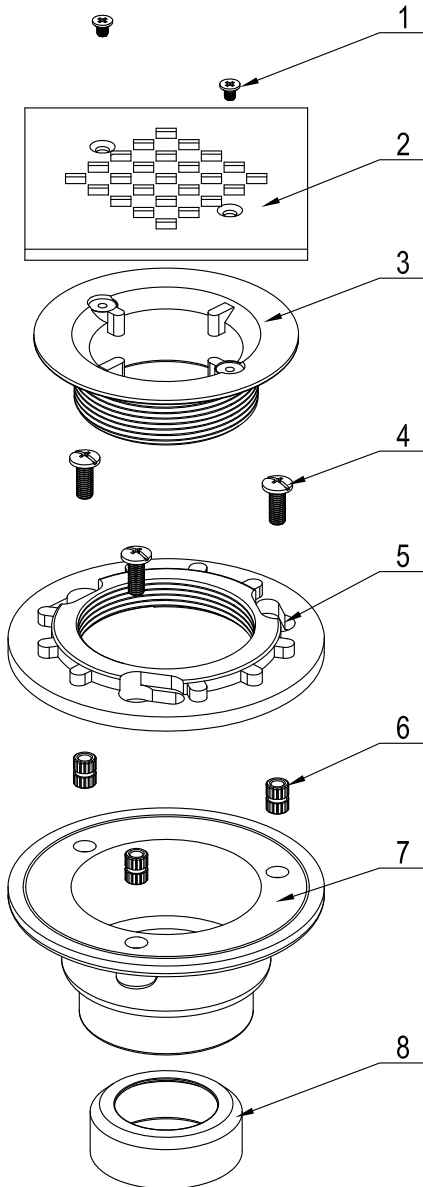

NO.	DESCRIPTION	QTY	MATERIAL
1	SCREW	2	STAINLESS STEEL
2	COVER	1	SS430
3	FLANGE	1	ABS
4	SCREW	3	STEEL
5	NUT	1	ABS
6	NUT	3	BRASS
7	BODY	1	ABS
8	TUBE	1	ABS